

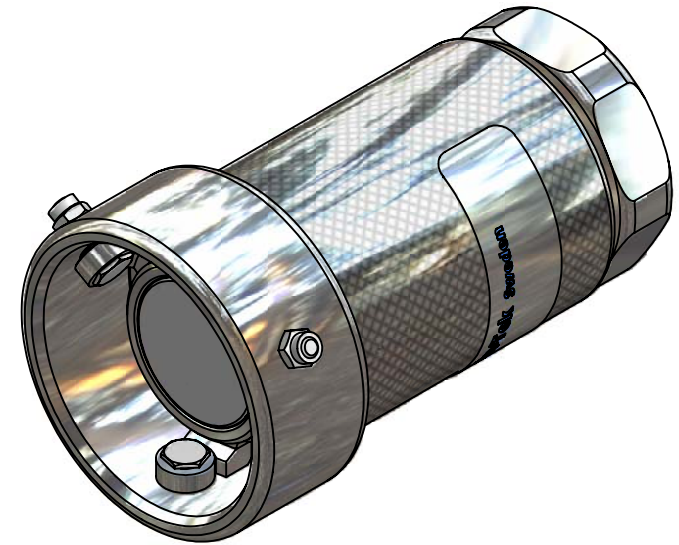

Notice: This drawing contains proprietary information and shall not be used or reproduced or its contents disclosed in whole or in part, without the prior written consent of the Mann Teknik AB

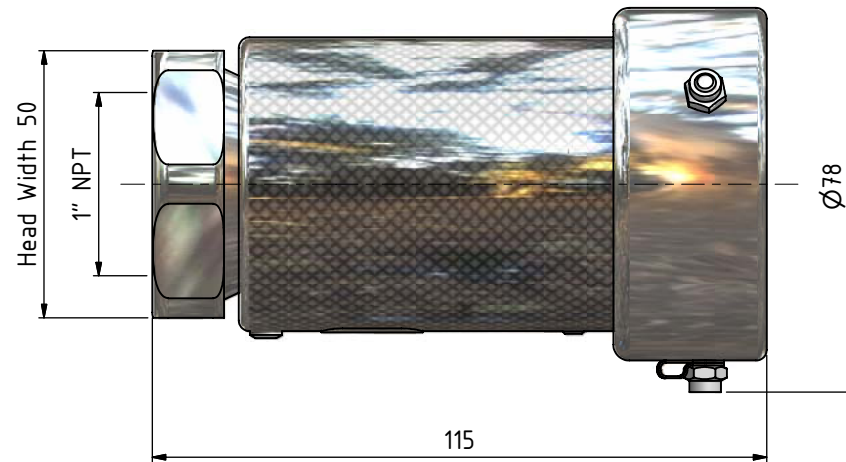
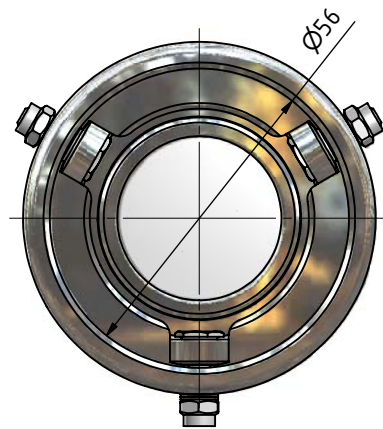

Dimensions are in metric.

Detail No:	Material	Ytbeh./Treatment	
	Designed/drawn by P. Nyberg	Scale: 1:1	Dimension with no tolerances acc to Machined SS-ISO 2768-1 medium Weld Forge SS-ISO 2768-1 coarse Surface roughness ISO 1302 Form & position tol SS ISO 1101
	Checked G. Kopplin	Date 2007-05-14	
	Approved T. Mann		
Hose Unit 1" Connection: 1" NPT			Data nr./Comp No. S104A4401 Blad/Sheet 1 / 1
			Drawing No. S104A4401-1 Rev.

NO.	Revision comprises	Date	Sign.	Appr by
-----	--------------------	------	-------	---------